

# Installation Instructions for Knob/Levers Lockset

## Step 1.

- Mark the Door as shown and use the template as guide.

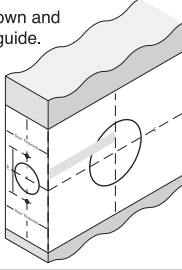

## Step 2.

- Drill the holes as shown.

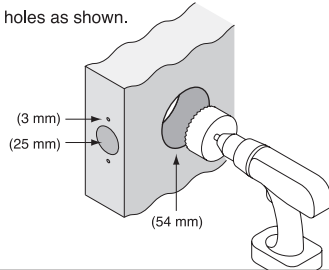

## Step 3.

- Prepare rebate
- Install the latch and screw to tighten.

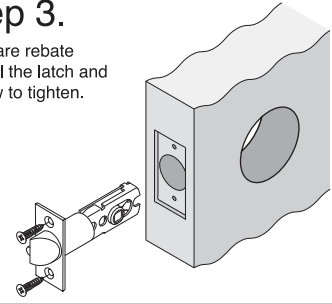

## Step 4.

- Prepare rebate
- Install the strike and screw to tighten.

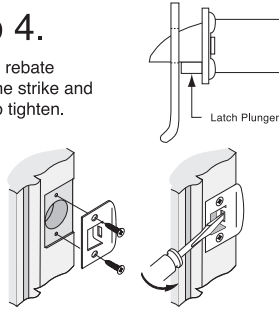

## Step 5.

- Installing the Knob/Lever

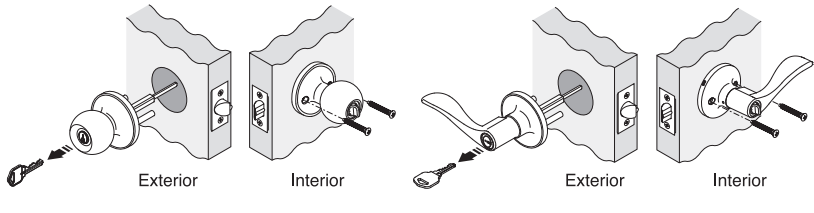

## Switching the Handles (if Required)

**Note:** Levers installed in reverse will not affect the product's performance.

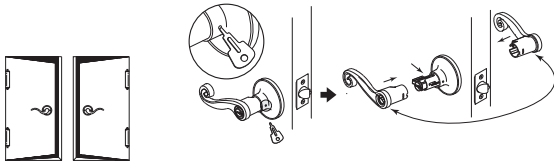

## Adjustable Latch

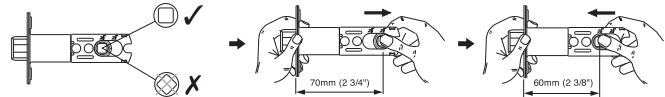

**NOTE:** Carefully follow these instructions when installing. Screws to be tightened to a recommended 2.5Nm torque.



Mark centre-line of latch hole

Mark centre-line of latch hole

FOLD HERE

Fit here on door edge

54mm hole

BACKSET 60mm (2 3/8")

BACKSET 70mm (2 3/4")

Fit here on door edge

Installation template for knob/lever lockset



gainsboroughhardware.com.au  
gainsboroughhardware.co.nz

